

# BF60 description

The BF60 is an electronic printed circuit board for use in do it yourself electronic cigarettes, like box or tube mods.

The following drawings show the optical appearance and dimensions of the board.

### Top View including Display

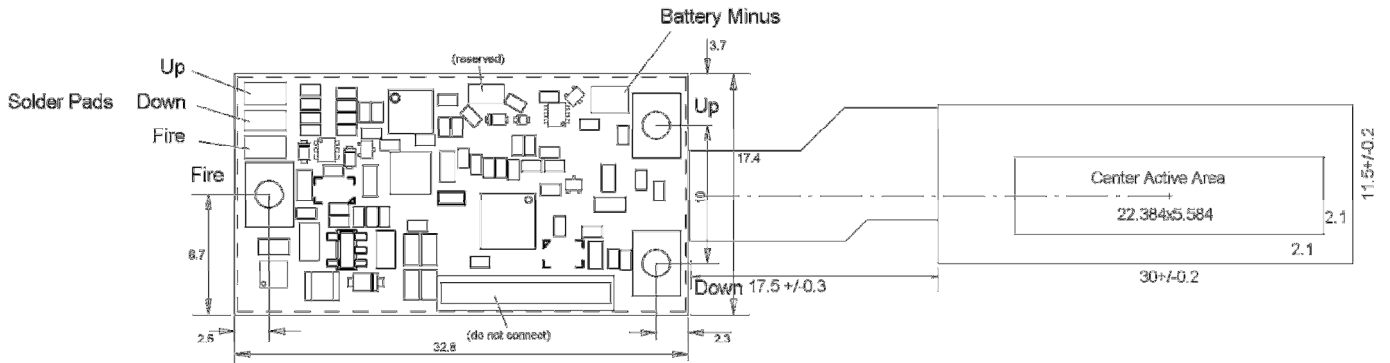

### Bottom View with Power Cabling

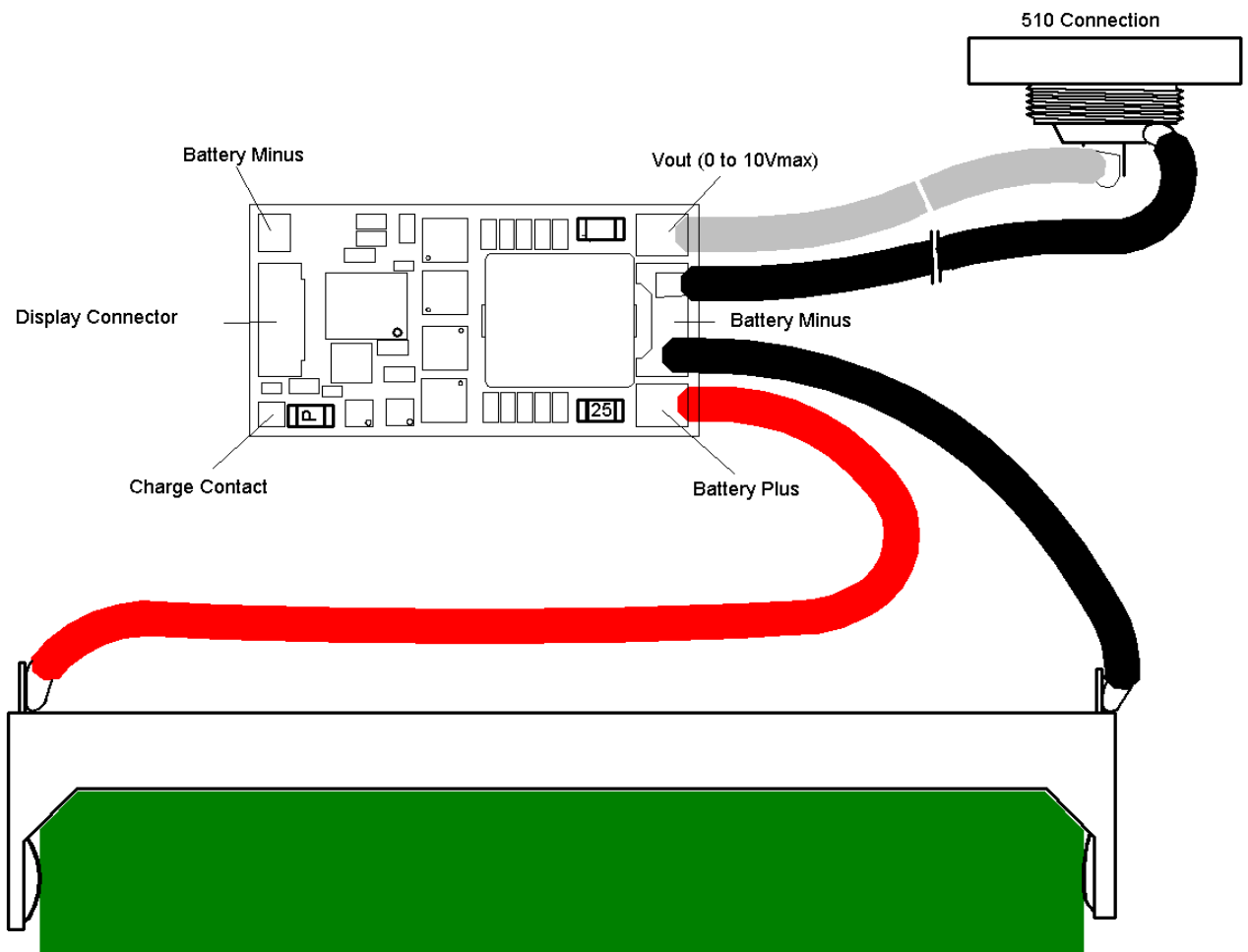

## Electrical Specification

- Single Battery Operation 2.6V..4.5V
- Output Power 5..60W
- Resistance Range 0.05 ...5 Ohm total
- Resistance Range 60W 0.2 ... 1.6 Ohm
- Output Current 18A max.
- Output Voltage 10V max.
- 0.91 Inch OLED display
- 0 current consumption when off
- On-board buttons and off-board buttons solder pads
- Large power cabling solder pads
- Reverse Polarity Protection
- Reverse Polarity Charger Solder Pad (see text)
- 25A input fuse
- 5 Operation Modes Power, Temp-Control, Heater-Protection, Boost, Bypass
- Programmable User Preferences
- Extended Functions Menu

The PCB provides a solder pad for the connection of a charging board, which is reverse polarity protected, because most available charging circuits do not have a protection, if the battery is inserted in the wrong orientation. Additionally, this pad is in series with a 3.5A resettable fuse (hold current) in case there is a severe battery problem.

## The Menu

The MOD is equipped with a graphical OLED display which provides all important information about the status during the vape and/or for 4 seconds after each vape (see display mode setting).

Display during/after Vape in Power Mode (Standard)

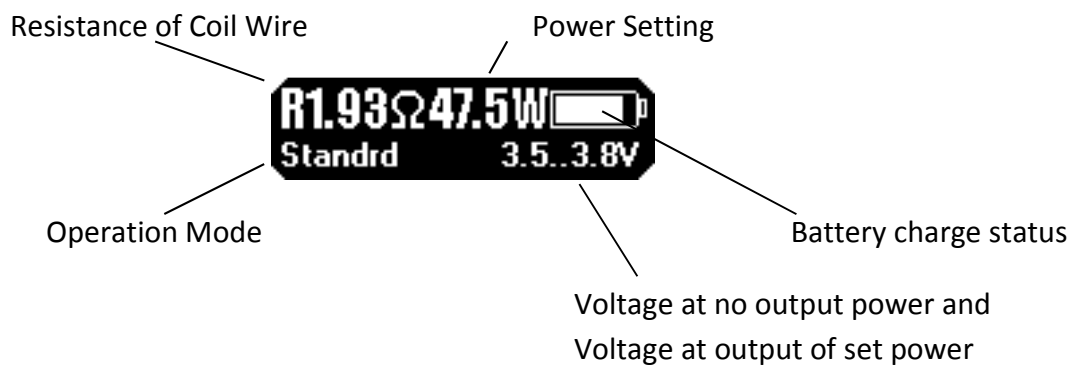

The displayed values depend on the operation mode. During temperature controlled vaping, the current coil temperature is displayed, the applied power, the wire type, coil resistance and the battery charge status (battery symbol).

Note that all values are permanently updated. Use this feature when you want to check the correct operation (just press the fire button with actually vaping, but watch the display).

Display during/after Vape in TC-Mode

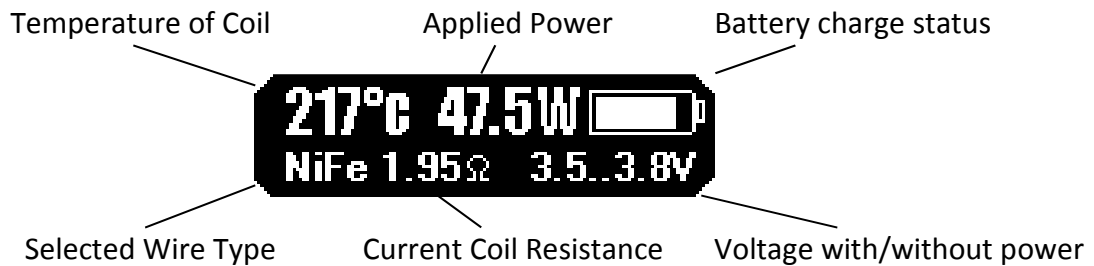

The following diagram shows the overall menu structure

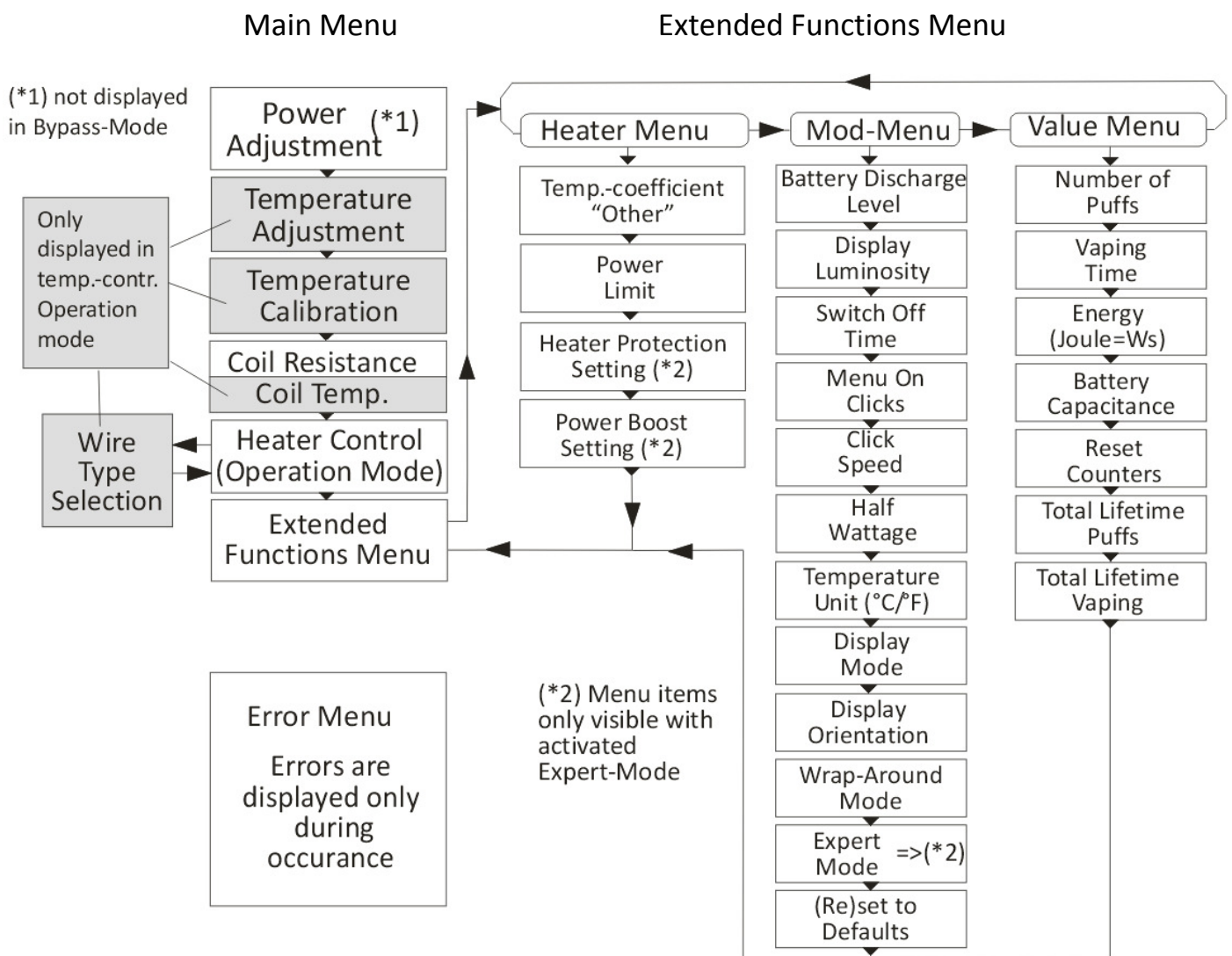

## The Buttons and Switching ON/OFF

The dicodes BF60 mod has three buttons: The vape/fire button positioned is in the middle of the short side of the PCB, opposite to the display. The plus- and minus buttons are at the short side where the display is attached (see drawing above).

Note that the buttons can also be installed off the board connected by wiring.

The mod is switched on by shortly pressing any button 5 times. The display shows “dicodes” and the user is led to the main menu.

A rectangular display with a black background and white text showing the word "dicodes" in a stylized, lowercase font.

For actively switching off the mod the fire button is to be pressed shortly 5 times and the display shows “Bye..”

A rectangular display with a black background and white text showing the text "Bye.." in a simple font.

Important Note: The BF60 differentiates between active switch off and the automatic switch off after the switch-off-time. When the mod was switched off driven by the automatic timer, the menu is entered by clicking MenuOnClk times any of the buttons (Menu On Clicks in the Extended Functions Menu).

A rectangular display with a black background and white text. The top line shows "MenuOnClk" followed by a small icon of a button. The bottom line shows "Standrd 1.92Ω 3.8-4.2V".

If MenuOnClk is set to 0, pressing the vape-button longer will immediately let you vape, i.e. the user can vape without delay, even when the mod was completely powered down (0 current consumption).

This feature together with the programmable switch-off time of 1/2/5 Minutes (longer times available as well) helps to spare battery charge and thus enables a longer overall vaping time.

We recommend to actively switch off the device by rapidly pressing the fire button 5times during transport to avoid unintentional firing.

## Key-Lock

To avoid an unintended change of settings, the buttons can be locked by pressing the plus- and minus button simultaneously: “Key Lock” is displayed. To unlock the buttons, again both buttons need to be pressed at the same time, indicated by “Key UnLock” shown on the display.

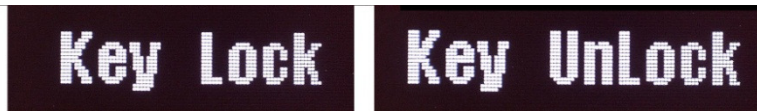

## Menu Navigation and Parameter Change

By means of the plus and minus buttons it is possible to navigate through the menu, as well as to increase and decrease values of a parameter after a short waiting until the value is displayed inverted (black on white).

The waiting time from navigation mode to the entry mode is adjustable by means of the parameter “Click Speed” in the extended functions menu.

Besides waiting, it is also possible to get from navigation to value entry mode (and back) by shortly pressing the fire button, i.e. skipping the waiting time. Thus a quick change of adjustments is possible. In the extended functions menu, the short pressing of the fire button also enables the fast stepping between the selection of one of the three different sub menus, again skipping the waiting time until the desired menu is displayed. At this point the fire button also acts as an escape option from the extended functions menu, by holding the button for a longer time and releasing it. Note that during the extended functions menu display, vaping (by pressing the fire button longer) is disabled.

TBD Option: With the parameter “MenuOnClk” set to 0, the menu structure is slightly changed as follows:

With this setting, the up/down buttons are always active without the need to enter the menu first (as MenuOnClk is 0).

Depending on the operation mode, up and down directly change the power setting (in Standard Mode) or the temperature setting (in TC-Mode).

To now enter the rest of the menu structure, the fire button has to be pressed shortly (!).

## Changing the Power Setting

In the Power menu the power setting can be changed by means of the plus/minus buttons in steps up to the Power-Limit (PLim, EF-Menu/Heater) value or down to 5W respectively. If the wrap-around is activated, the setting rolls over at the PLim/5W border. When wrap-around is disabled, further increase or decrease is blocked at the borders. The Power-Limit value is adjusted in the Extended Functions Sub-Menu “Heater” and provides a protection feature for atomizers which are not prepared for high wattage or to reduce the power range intentionally.

The wattage step size is 1 Watt below 20W, 2W from 20W to 40W and 5W above 40W, but can be set to 0.5W, 1W and 2.5W respectively in the mod-menu with "Half Watt=1".



Power ⬆️ 45.0W  
NiFe 1.94Ω 3.9-4.3V

**Note:** In temperature control mode (TC-mode) the Power setting defines the permitted power for the heating up phase of the coil.

If the power level is smaller than the value needed to achieve the selected temperature, the operation changes from a temperature regulator to a temperature limiter. Keep this in mind, if the mod doesn't reach the expected temperature. If the power level is sufficiently high, it sets the heating up speed of the coil until the set-point temperature is reached. After the heating up phase, the power is reduced automatically by the temperature controller.

In the operation mode "Bypass" (mechanical mod), changing the power setting is not available, because the power is defined by the battery voltage and coil resistance. The menu "Power" is not displayed in this case, but the value display during and after the vape shows the actual power output to the coil.

When the battery voltage decreases, power is reduced starting from the voltage set by the parameter UbatMin (EF-mod menu) plus 0.5V and ending at 10W at UbatMin. E.g. UbatMin=2.5V and Power=40W => Full 40W until battery voltage is at 3.0V, and then reduced to 34W at 2.9V, 28W at 2.8V and so forth. When the power is reduced, the battery symbol in the display starts blinking. We recommend to set UbatMin between 2.5 and 2.7V.

### Setting the Temperature

This Menu item is only available and displayed if temperature controlled vaping is selected (see Heater-Control menu item below). So the menu structure adapts to the selected operation mode. The Temperature Up/Down menu sets the setpoint for the coil temperature during vaping. The temperature setpoint can be selected from 120°C to 280°C (250°F- 540°F) in steps of 5°C (10°F). To achieve a high precision temperature control, a correctly performed reference measurement (TempCal Init) is mandatory, see next item.



Temp ⬆️ 215°C  
NiFe 1.94Ω 3.9-4.3V

## Manual Coil Temperature Calibration

This Menu item is only displayed if temperature controlled vaping is selected (see Heater Control menu item below). For the use of temperature controlled vaping, the calibration measurement is a very important part of it.



The Temperature calibration measures the coil resistance at room temperature (20°C) as the reference for temperature controlled vaping. This together with the wire's temperature coefficient enables the mod to calculate the coil's temperature. The calibration must be confirmed in a second step to avoid accidental activation. After confirmation the display shows "process" until the calibration completed. It is extremely important to understand, that, if the calibration is performed at a temperature other than 20°C, the control will regulate a constant temperature, but with an offset deviation. So take the ambient temperature during the temperature adjustment in to account. Similiar, if a wrong temperature coefficient was adjusted, the actual temperature might deviate dramatically from the set-point (here it is a factor and not an offset).

Always perform a calibration, when a new atomizer is attached, even if it is made from the same coil material.

For further information about this topic, please read the "Application Note for Temperature Controlled Vaping", available on the dicodes-mods website.

## Coil Resistance and Coil Temperature

This is a display only menu item. The coil resistance is displayed in a range from 0.00 to 9.90 Ohms. If temperature controlled vaping is selected, the current measured coil temperature is also displayed, if not, the display shows T ---.

If the display does not show 20°C even with cooled down atomizer, it is recommended to perform a manual calibration again.

Note that for coils with very low resistance, like Nickel-coils, a slight mechanical rearrangement (tightening the atomizer) can lead to drastical changes in the temperature control due to the change of contact resistances. We therefore recommend to use other than Nickel coils, e.g. The NiFe30 (RESISTHERM) wire from dicodes.

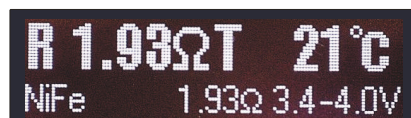

## Heater Control (Operation modes)

The mod can be used in up to 5 operation modes. The mode can be selected in the menu HCtrl.

The default operation is either standard (0, power setting) or temperature controlled vaping (1). With the "Expert Mode" (Extended Functions Mod-Menu) enabled, additional operation modes are Heater Protection (2), Power Boost (3), and Bypass (4, mechanical mod).

With Expert Mode disabled, the menu options 2..4 are masked out.

### 0. Standard Mode



In the standard operation mode the wattage selected in the power setting menu is applied to the coil, unless the voltage would be greater than 10V or the current greater than 20A, which depends on the coil resistance.

For example with a coil resistance of 4 Ohms and a power setting of 40W, the required voltage at the coil is 12.7V. With 4 Ohms the maximum wattage is 25W ( $(12V)^2/4R=25W$ ). Or, if the coil resistance is 0.1 Ohm the maximum power is 40W, because  $(20A)^2*0.1\text{Ohm}=40W$ .

As can be seen from the examples, with high coil resistance the power is limited by the maximum voltage of 10V and with low resistances by the maximum current of 20A.

Resistances of 0.05 to 5 Ohms are possible but with a reduced power.

### 1. Temperature controlled vaping



In this mode the mod will regulate the temperature of the coil to the pre-set value, except the power setting is too low to achieve the temperature. So please note to adjust the power setting to a value high enough, if you choose temperature controlled vaping. Otherwise the temperature regulation changes to a temperature limitation mode.

When HCtrl is set to 1, the menu directly jumps to the selection of the wire type. Here the user can select between dicodes-wire (NiFe30), Nickel 200 (Ni), Titan(Ti), Tungsten (W, Wolfram), Stainless Stell (Inox) and "Other". With "Other" selected, the temperature coefficient defined in the Extended Functions Menu under item "Tmp. Cof" is used. The value of the selected coefficient is displayed behind "Wire".

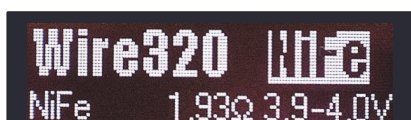



For commonly used wires, the predefined coefficients are: NiFe30=320, Nickel200=620, Titanium=350, Tungsten=440 and Stainless Steel=105. Note that there are different alloys for Titanium and Stainless Steel on the market, so the predefined values can deviate from the actual wire-value you use. In those case it is preferable to choose "Other" as the wire type and set the value of the wire in the extended functions heater Menu "TempCof". The range for the coefficient is 050 to 650. If you use the dicodes wire (RESISTHERM) it is guaranteed that the wire will always have the same coefficient, because the wire was especially designed for temperature regulation purposes. The regulation accuracy is best then, as the combination of resistivity and high coefficient is very good. Note for using Nickel wire: Nickel has a high and always precise temperature coefficient (Ni200). But Nickel is not so easy to handle, because it is quite soft and it leads to very low resistance coils, because of its high conductivity. For the regulation accuracy smallest changes of contact resistances due to atomizer movements (tightening) or mechanical thermal elongations lead to poor regulation accuracy.

## 2. Heater Protection Mode (only when Expert Mode=1)



The heater protection mode is a periodic interruption of the power applied to the coil. The duration and the repetition rate of the interrupts is selected by means of the parameter "Heater Prot" in the extended functions mod-menu. The repeated power interrupts helps to avoid a break in liquid flow and thus an increase in temperature. The table below shows the relation between power interrupt and appliance time in dependence of the parameter "Heater Prot":

Value Heater Prot	On-Time [ms]	Off-Time [ms]	Powerfactor
1	400	100	0.80
2	600	100	0.86
3	800	110	0.88
4	1000	120	0.89
5	1350	150	0.90
6	2000	200	0.91
7	2000	180	0.92
8	2000	150	0.93
9	2000	100	0.95
10	2000	80	0.96

3. Power Boost Mode (Only with Expert Mode =1)



The Power Boost Mode enables an initial short term high power pulse applied to the coil (boost). The boost power is the value of the parameter “Power Limit”. Beside 3 selectable initial boost lengths, further options generate a periodic boost pulse with different length and repetition rate. An initial boost is for quick coil heat-up. The periodic boost lets the coil temperature pass a certain range all the time. In this case different flavours within the liquid, which all develop their taste at different temperatures, are all addressed by the varying temperature.

We recommend to set the normal power (not the boost) to much lower values, when using the periodic boost, because the average power is increased by the boosts and temperature gets higher therefore.

Value of Power Boost	Boost-Time [ms]	Time at Power Setting [ms]	Comment
1	300	-	Start-Boost
2	450	-	Start-Boost
3	600	-	Start-Boost
4	50	500	Periodic Boost
5	80	600	Periodic Boost
6	120	700	Periodic Boost
7	160	800	Periodic Boost
8	200	900	Periodic Boost
9	250	1000	Periodic Boost
10	300	1000	Periodic Boost

Note: If the power setting equals the power limit value, the boost has no function, as it is limited to that value as well. For a graphical diagram showing the boost operation options, please refer to the following sketch.

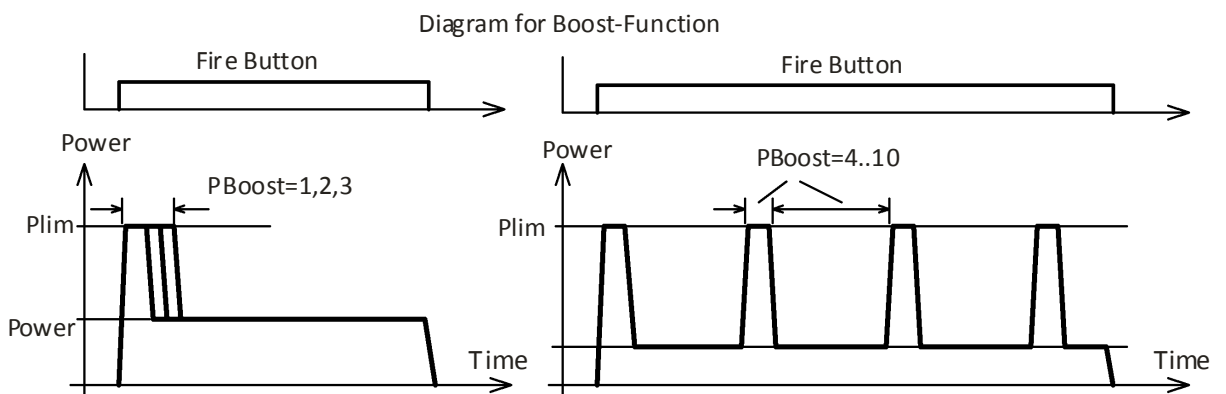

## Extended Functions Menu

The Extended Functions Menu provides three logically grouped sub-menus:

- Heater Menu Settings related to the heater or coil
- Mod Menu Settings related to the individual usage and appearance
- Value Menu Provides several statistics of vaping

The Extended Functions Menu offers a lot of setting options of the mod, to provide the highest possible flexibility for the user to individually adjust it to whatever preferences. Normally, once the settings were made, the user will need to change the parameter rarely. In order to keep the main menu as short as possible, the extended functions menu was created.

The many options may frighten some of the users initially. But without the extended functions menu the mod would not be able to address all different customer requirements. Please take a bit of time to get familiar with the menu. We are sure, as soon as you have gained an overview, the individual setup is a walk-over.

### EF- Heater Menu



**Tmp. Coef** 335  
NiFe 1.87Ω 3.8-4.1V

Change wire temperature coefficient of "Other" wire (\*1). Default 320



**Htr Prot** 7  
NiFe 1.87Ω 3.8-4.1V

Select heater protection mode (1..10). Default 6

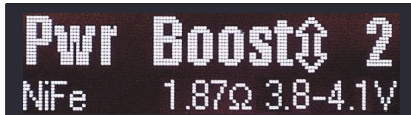

**Pwr Boost** 2  
NiFe 1.87Ω 3.8-4.1V

Select power boost mode (1...10). Default 3



**Pwr Lim** 55W  
NiFe 1.87Ω 3.8-4.1V

Set Power Limit (60W max). Default 60W

\*1 ) The temperature coefficient selects the type of wire material, range 050 to 650: When TC-mode is selected (Main menu HCtrl=1), the user must select the wire type to be NiFe30 (dicodes wire), Ni200, Titanium, Tungsten (Wolfram), Stainless Steel (Inox) or "Other". The value for "Other" is adjusted here. The values of the redefined wire-types are 320=dicodes-wire, 620=Nickel, about 105=Stainless Steel, 50=Titanium (varying literature values, danger: fire hazard), 440=Tungsten (Wolfram). Value to select = Literature-value\*10E5 K. Example: Ni 6.2E-3\*1/K \* 10E5\*K => 620

## EF- Mod Menu

**UBatMin 2.6V**  
NiFe 1.87Ω 3.8-4.1V

Set the minimum discharge voltage level of the battery. Default 2.7V

**Lumen 1**  
NiFe 1.87Ω 3.8-4.1V

Set the OLED display luminosity. Default 4

**SwOff Time 2**  
NiFe 1.87Ω 3.8-4.1V

Select the automatic power off time in minutes:  
1-2-5-10-15-20-30-60 Default 5 minutes

**MenuOnClk 1**  
NiFe 1.87Ω 3.8-4.1V

Select the number of clicks to activate the menu. Default 1

**Clk Speed 3**  
NiFe 1.87Ω 3.8-4.1V

Select the click speed for menu navigation and parameter entry

**Half Watt 0**  
NiFe 1.87Ω 3.8-4.1V

Select the wattage steps: 1W/0.5W (<20W), 2W/1W (20-40W), 5W/2.5W (>40W). Default 3

**Temp.Unit °C**  
NiFe 1.87Ω 3.8-4.1V

Select temperature unit to Fahrenheit or Celsius  
Default °C

**Disp.Mode con**  
NiFe 1.87Ω 3.8-4.1V

Selects OLED display modes to off (display only during menu navigation), post (display on for 4 seconds after the vape), con (display on during and after vape)

**Disp.Dir R**  
NiFe 1.87Ω 3.8-4.1V

Selects display direction  
(Lefthand/Righthand)

**Wrap.Mode 1**  
NiFe 1.87Ω 3.8-4.1V

Wrap around or stop at min/max positions of power and temperature

**Exp.Mode 0**  
NiFe 1.87Ω 3.8-4.1V

Expert mode enables usage of Power Boost, Heater Protection and Bypass Modes. Default 0

**SetDef Init**  
NiFe 1.87Ω 3.8-4.1V

Set all values to their defaults (entry must be confirmed)

EF- Value Menu

**Cycles** 17  
NiFe 1.87Ω 3.8-4.1V

Number of vapes/puffs since last counter reset

**Time** 0:00:04  
NiFe 1.87Ω 3.8-4.1V

Time of vaping since last counter reset  
Format H:MM:SS

**Energy** 24J  
NiFe 1.87Ω 3.8-4.1V

Energy amount during vape since last counter reset

**BatCap** 0.001Ah  
NiFe 1.87Ω 3.8-4.1V

Amount of capacity taken form the battery during vape since last counter reset

**Reset Cntr** 0  
NiFe 1.87Ω 3.8-4.1V

Setting to 1 resets all counters above

**TotCyc** 21  
NiFe 0.00Ω ...-3.7V

Total cycle counter, not resettable

**TotTim** 0:00  
NiFe 1.87Ω 3.8-4.1V

Total time counter, not resettable. Format HHHH:MM

## Error Messages

If an error occurs, the mod directly jumps to the error menu and displays the error number and a mnemonic (short-term) description.

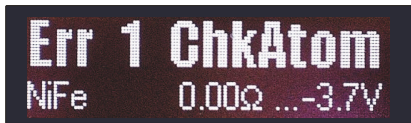

- 0 OvrVolt: The input voltage is too high. The dicodes 2395 is prepared for the use of one or two batteries. If the input voltage exceeds 9V this error message is displayed.
- 1 ChkAtom: No atomizer detected or open coil.
- 2 TempRef: A problem during the temperature reference measurement occurred Repeat the calibration procedure.
- 4 OverCur: Short on coil or coil breakdown (open)
- 5 LowBat: The battery voltage under load (with current drained from it) has reached the minimum discharge level, defined with parameter UbatMin in the extended function mod-menu.
- 6 EleHot: The electronics have heated up too much and needs to cool down. This error will not occur with normal usage of the mod.
- 7 TimeOut: The maximum puff-time is limited depending on power. For a power <20W it is 20 seconds. Above 20W it decreases by 0.5 seconds per Watt, and from 40W it is kept at 10 seconds.